

# Low-Frequency Optimization Using Multiple Subwoofers\*

TODD WELTI AND ALLAN DEVANTIER

TWolti@harman.com

(ADevantier@harman.com)

*Harman International Industries Inc., Northridge, CA 91329, USA*

At low frequencies the listening environment has a significant impact on the sound quality of an audio system. Standing waves within the room cause large frequency-response variations at the listening locations. Furthermore, the frequency response changes significantly from one listening location to another; therefore the system cannot be equalized effectively. However, through the use of multiple subwoofers the seat-to-seat variation in the frequency response can be reduced significantly, allowing subsequent equalization to be more effective. Three methods to reduce seat-to-seat variation are described, including a novel approach based on simple signal processing. The desired result in each case is to allow the system to be equalized over a seating area rather than just one seat. Results are shown for several listening rooms.

## 0 INTRODUCTION

The advent of home theater and multichannel audio has placed significant demands on the low-frequency performance of audio systems. First, theatrical low-frequency effects combined with digital media have increased the maximum output requirements well beyond those of the stereo LP era. Second, home theater and multichannel audio have transformed listening from a solitary event into a social one. As a result the low-frequency performance needs to be optimized over a seating area rather than at a single location. Low-frequency equalization over an area is complicated by the wide seat-to-seat frequency response variations that are caused by the standing waves within the listening environment. A fundamental precept of this paper is that optimization is achieved when the responses at multiple seats are as similar to each other as possible. Making them flat is then simply a matter of global equalization. This consistency of amplitude response is a fundamental goal for the current investigation.

A common feature of consumer multichannel audio systems is bass management, which redirects the low-frequency information from all the audio channels into a

single subwoofer channel. This low-frequency signal can be manipulated and distributed to a number of subwoofers located strategically in the listening room. From an intuitive standpoint it seems likely that putting a large number of subwoofers at different locations in the room might excite room modes in a more “balanced” manner than a single source. Typical approaches to this problem have involved exciting the standing waves within the room equally but out of phase, or trying not to excite them at all. There is not much agreement on how many subwoofers are required, or where to place them.

This paper outlines three methods of using multiple subwoofers to reduce seat-to-seat amplitude response variations so that the system can then be equalized effectively over the listening area. One method assumes a rectangular room and involves using standardized subwoofer locations. We may refer to this as standardized positional optimization. The second method can be used for any shape room, and uses analytically or adaptively derived high-order filters to try to match a target curve at the seats. The third method, sound field management (SFM),<sup>1</sup> can also be used for any shape room but uses only subwoofer placement and very simple signal processing. The second and third methods are based on in-room measurements. This paper focuses on positional optimization and SFM because of their relative ease of implementation and certain other advantages, which are outlined in this paper.

\*Manuscript received 2004 June 22; revised 2006 March 20 and April 10.

This work is based on papers presented at the 112th Convention (Munich, Germany, 2002 May 10–13) and the 115th Convention (New York, 2003 October 10–13) of the Audio Engineering Society.

<sup>1</sup>Patent pending.

Some limiting assumptions are made:

- 1) More than one seat is to be optimized.
- 2) It is assumed that the system in question will be equalized.
- 3) Maximizing the output of the system is considered a secondary goal.

### 1 MODELING THE LOW-FREQUENCY BEHAVIOR OF THE ROOM

At low frequencies the sound quality of an audio system is dominated by the room. The modal behavior in rectangular rooms is well described in the literature [1]–[3]. However, there are some aspects of room modes that make “eyeballing” the expected room responses from generalized standing-wave plots risky. Modal resonances have a finite bandwidth, that is, they do not occur at only one discrete frequency. This means that adjacent modes will overlap to some degree (quite a bit if the room has two or more similar dimensions). If you further consider that the modal response is complex, that is, has a phase component, it can be seen that the interaction of adjacent modes over a range of frequencies is complicated. When you have a defined listening area rather than a single seat, things become extremely complicated.

Due to the complexity of the room’s modal response and the desire to investigate a large number of subwoofer–room configurations, an accurate room model is needed. Fortunately modeling a rectangular room is relatively straightforward. A room modeling program was written using Matlab [4] to model various configurations. The model is based on the following well-known steady-state closed-form solution of the wave equation in a rectangular enclosure:

$$p_r \cong \frac{\rho c^2 Q_0}{V} e^{-i\omega t} \sum_N \frac{\varepsilon_{n_x} \varepsilon_{n_y} \varepsilon_{n_z} \psi(S) \psi(R)}{2\omega_N k_N \omega + i(\omega_n^2 / \omega - \omega)} \quad (1)$$

where

- $p_r$  = total reverberant SPL
- $Q_0$  = volume velocity of source
- $\rho$  = density of medium
- $c$  = speed of sound in medium
- $V$  = room volume
- $\omega$  = angular frequency
- $\omega_N$  = mode natural angular frequency
- $k_N$  = three-dimensional damping factor
- $\varepsilon_n$  = scaling factors (1 for zero-order modes, 2 for all other orders)

$\psi(S) \psi(R)$  = source and receiver coupling functions.

The damping factor  $k_N$  is related to the absorption of the room boundaries. In our model an average absorption factor of 0.05 is assumed for all boundaries, corresponding to a fairly acoustically “live” space. The terms  $\psi(S)$  and  $\psi(R)$  are three-dimensional cosine functions which describe the coupling of the source and the receiver to the room modes at any particular location. This is also the spatial distribution of the mode, as shown in Fig. 1.

Eq. (1) gives the reverberant response in a room. The total sound pressure level  $p_t$ , is the sum of this and the direct sound from the source  $p_d$

$$p_t = p_r + p_d \quad (2)$$

### 2 STANDING-WAVE FREQUENCIES IN SIMPLE RECTANGULAR ROOMS

For simple rectangular listening rooms standing waves occur at frequencies given by the following well-known formula:

$$f_{(n_l, n_w, n_h)} = \frac{c}{2} \sqrt{\left(\frac{n_l}{l}\right)^2 + \left(\frac{n_w}{w}\right)^2 + \left(\frac{n_h}{h}\right)^2} \quad (3)$$

where

- $c$  = speed of sound in air, typically 344 ms/s
- $n_l$  = integer values 0, 1, 2, 3, . . .
- $l$  = length of room, meters
- $n_w$  = integer values 0, 1, 2, 3, . . .
- $w$  = width of room, meters
- $n_h$  = integer values 0, 1, 2, 3, . . .
- $h$  = height of room, meters.

Modes that depend only on a single room dimension are called axial modes, modes that are determined by two room dimensions are called tangential modes, and modes that are the result of all three room dimensions are called oblique modes. For most rooms the axial modes dominate the low-frequency performance. However, the first tangential mode may be relevant for rooms with exceptionally stiff walls. Experience suggests that the remaining tangential and oblique modes are rarely significant.

Fig. 2(a) is a pictorial representation of the first four axial modes through a single room dimension for an instant in time, normalized so that the pressure of all modes equals + 1.0 at the left “wall.” Sound pressure maxima always exist at the room boundaries (the two ends of the figure). The second-order mode has a maximum at the center as well, while the first- and third-order modes pass through a minimum at this point. The point where the sound pressure drops to its minimum value is commonly referred to as a “null.” In theory if there is no mode damp-

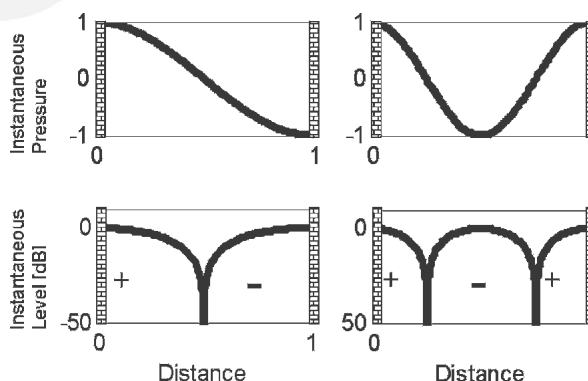

Fig. 1. Representation of first- and second-order axial-mode spatial distribution in one dimension (normalized from 0 to 1) for an instant in time. Both instantaneous sound pressure and more commonly used instantaneous sound level in dB are shown.

ing at all, the sound pressure at the nulls drops to zero, or  $\infty$  dB. However, in the rooms investigated here the response dip at the nulls is typically in the  $-25$ -dB range.

## 2.1 Optimization Using a Single Subwoofer

Attempts at optimizing the location of subwoofers in small rooms have been documented as far back as 1958 [5], where boundary effects were investigated. The main thrust of this and other early efforts [6]–[8] was to achieve a more uniform radiated power from a single woofer by optimizing its position relative to adjacent room boundaries. No consideration is made for the shape or size of the room or the location(s) of listeners. This amounts to the optimization of one subwoofer for a seating area that encompasses the entire room, and would be appropriate only in the most general sense. As soon as room dimensions and seating locations are specified, the problem becomes more complicated.

Early studies of the optimization of a single subwoofer in a small room where seating locations are specified and the full modal response of the room is accounted for include [9]–[11]. By carefully locating the loudspeaker and listener within the room the frequency response can be made relatively smooth at a single listening location, as in the following example. Fig. 2(b) represents a potential subwoofer–listener location combination within a single room dimension. The listener, represented by the smiley face, is located away from the spatial peaks and nulls for the first- and second-order modes while the subwoofer is located in the null of the third-order mode. As a result the frequency response at the listening location will be relatively smooth. Unfortunately listening positions just a few

feet away from the “sweet spot” (locations 1 and 2) would be very different from the main listening location and each other. With only one subwoofer this is unavoidable.

## 2.2 Mode Canceling

By locating multiple loudspeakers in the listening room standing waves can be reduced by exploiting destructive interference. The idea was first suggested by Toole [12]. Some have called this “mode canceling.” The concept is depicted in Fig. 2(c), where we have located two loudspeakers such that the odd-order modes are “eliminated.” Each subwoofer excites a series of standing waves, but the acoustical response of the odd-order modes at one side of the room is  $180^\circ$  out of phase with respect to the other side, thus the modes are driven destructively and the subwoofers effectively cancel each other. Unfortunately the even-order modes from each subwoofer are in phase and no mode canceling occurs for these standing waves.

In Fig. 2(d) we have added a third subwoofer at the center of the standing-wave pattern. This subwoofer is at the null of the odd-order modes and hence does not excite these modes. This leaves the two outside woofers to cancel one another just like those in Fig. 2(c). If the gain on the middle subwoofer is set to  $+6$  dB relative to the other two (since there is only one subwoofer in the center trying to cancel two at the room boundaries) the second-order mode is effectively canceled. As a result the first three modes have been canceled. This is just an example; there are numerous possible configurations for various modes. It is interesting to note that some of the most severe cancellations occur between modes, and some of the most signifi-

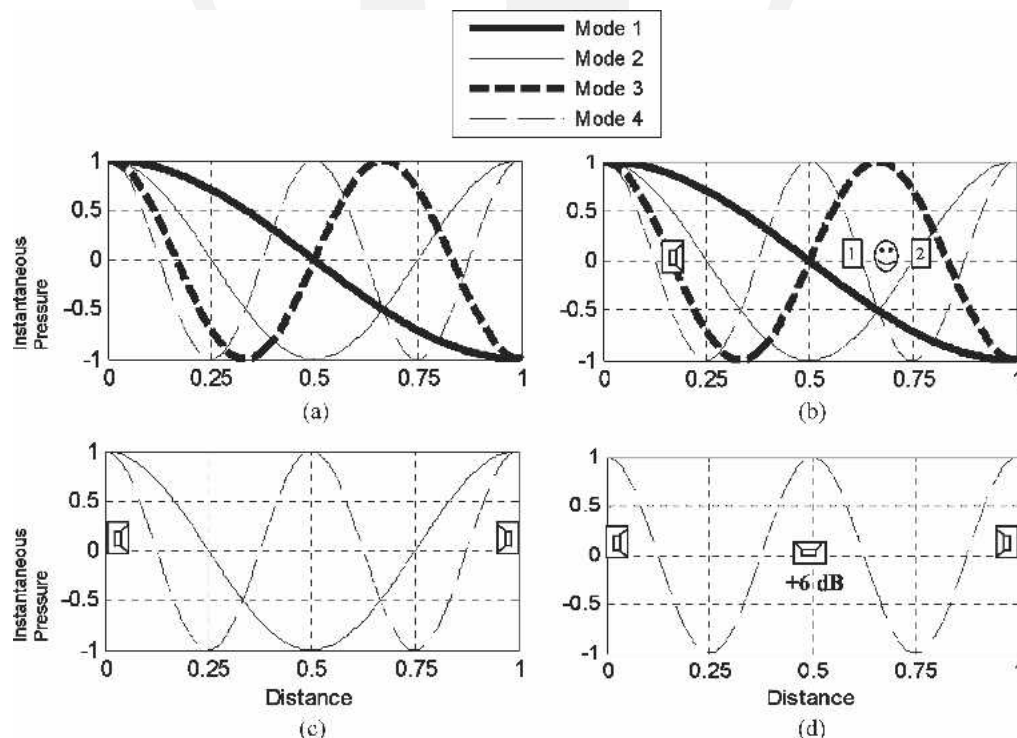

Fig. 2. (a) Pictorial representation of first four axial modes for a single normalized room dimension for an instant in time. (b) Locations for loudspeaker and listener (smiley face) that should yield a smooth frequency response at the listener. (c) Listening locations 1 and 2 are less favorable. Cancellation of odd-order modes using two subwoofers. (d) Combination of noncoupling subwoofer position and cancellation. First three modes are not excited or are canceled.

cant improvement from mode canceling also occurs there. Though modal excitation peaks at the mode’s resonant frequency, there is some excitation at nearby frequencies as well. Where the resonant frequencies of two or more modes are close to each other, they can overlap significantly. If there is an out-of-phase condition, severe cancellations can and do occur. These interactions are all subject to optimization.

### 2.3 Characterizing the Low-Frequency Response of the Subwoofer–Room System

Here we will define three metrics that we will use to characterize the low-frequency performance of the subwoofer–room system.

*Mean Spatial Variance (MSV).* The variance of the sound level<sup>2</sup> in dB as a function of the seating location (typically four to six seats) is calculated for each frequency, and from this the mean variance is calculated. This is a measure of seat-to-seat consistency in the amplitude response, as will be shown in Eq. (4). *A* is the total amplitude response in dB at seat *s*. The metric calculation is taken over the frequency band of interest (typically 20 to 80 Hz in this investigation). Though it has not been proven that the metrics used here correlate exactly with listener preference, minimizing the seat-to-seat variation is a reasonable goal if it is assumed that the system is to be equalized.

*Variance of Spatial Average (VSA).* The mean sound levels for a number of locations are calculated over the frequency band of interest, and then the variance of this spatial average is calculated across the frequency band of interest. This is a measure of overall amplitude response flatness for all seats. It is primarily of interest if the system under consideration will not have the benefit of global equalization.

<sup>2</sup>“Sound level” is used as a relative measure here; there is no absolute reference. In practice the transfer function from subwoofer to seat is used,  $A = 20 \cdot \log_{10}[\text{abs}(R)]$  (see Eq. (7), Fig. 8).

*Mean Output Level (MOL).* The mean sound level of all seats over the frequency range of interest is calculated. Typically the maximum output capability of subwoofers decreases at lower frequencies, which determines the ultimate sound pressure level (SPL) that this system can achieve. For this reason we calculate the MOL for the 20–40 Hz range. Note that we assume that all subwoofers operate linearly, that is, there is no power compression.

The MSV, VSA, and MOL metrics can be stated as follows:

$$\text{MSV} = \text{mean}\{\text{var}_s[A(s, f)]\} \tag{4}$$

$$\text{VSA} = \text{var}\{\text{mean}_s[A(s, f)]\} \tag{5}$$

$$\text{MOL} = \text{mean}\{\text{mean}_s[A(s, f)]\} \tag{6}$$

where the subscript *s* denotes that the mean or variance is calculated across seats, resulting in one value at each frequency bin. Fig. 3 shows an example of how the metrics are calculated.

### 3 BASS MANAGEMENT VERSUS MULTICHANNEL BASS

Virtually all methods of optimizing the frequency response of subwoofers in rooms assume a single audio channel as a source for all subwoofers, that is, they are bass-managed. To assume otherwise introduces an unknown and possibly time-varying element into the optimization, namely, the relationship of one subwoofer channel signal to another (such as phase). The most that can be done in such a case is to equalize each channel flat at one location in the room. Though this might work for decor-related signals, the much more prevalent correlated bass signals will then result in cancellation dips at some locations in the room. If there are multiple subwoofers reproducing each channel, each group of subwoofers could perhaps be optimized separately, but this divides the number of subwoofers in the optimization by the number of channels, greatly reducing the effectiveness.

Frequency	Raw Data							Mean Spatial Variance
	20	30	40	50	60	70	80	
Seat 1	-17.7	-11.7	-19.1	-13.9	0.5	1.3	-2.1	Mean. = 11.3
Seat 2	-16.4	-14.1	-19.5	-13.0	2.1	2.9	0.2	
Seat 3	-18.1	-13.8	-18.2	-13.8	-0.5	3.2	1.8	
Seat 4	-14.5	-4.3	-13.0	-21.2	-7.1	2.2	-8.0	
Seat 5	-13.0	-8.2	-19.8	-18.6	-0.9	6.9	-7.1	
Spatial Variance	4.7	17.3	7.9	13.1	12.3	4.5	19.2	

(a)

Frequency	Raw Data							Variance of Spatial Average
	20	30	40	50	60	70	80	
Seat 1	-17.7	-11.7	-19.1	-13.9	0.5	1.3	-2.1	Var. = 71.2
Seat 2	-16.4	-14.1	-19.5	-13.0	2.1	2.9	0.2	
Seat 3	-18.1	-13.8	-18.2	-13.8	-0.5	3.2	1.8	
Seat 4	-14.5	-4.3	-13.0	-21.2	-7.1	2.2	-8.0	
Seat 5	-13.0	-8.2	-19.8	-18.6	-0.9	6.9	-7.1	
Spatial Average	-15.9	-10.4	-17.9	-16.1	-1.2	3.3	-3.0	

(b)

Frequency	Raw Data							Mean Output Level (20-40 Hz used)
	20	30	40	50	60	70	80	
Seat 1	-17.7	-11.7	-19.1	-13.9	0.5	1.3	-2.1	Mean. = -14.8
Seat 2	-16.4	-14.1	-19.5	-13.0	2.1	2.9	0.2	
Seat 3	-18.1	-13.8	-18.2	-13.8	-0.5	3.2	1.8	
Seat 4	-14.5	-4.3	-13.0	-21.2	-7.1	2.2	-8.0	
Seat 5	-13.0	-8.2	-19.8	-18.6	-0.9	6.9	-7.1	
Spatial Average	-15.9	-10.4	-17.9					

(c)

- Mean Spatial Variance  
Seat-to-seat consistency of amplitude responses
- Variance of Spatial Average  
Overall flatness of amplitude responses
- Mean Output Level  
Low frequency output

(d)

Fig. 3. Example calculations. (a) MSV. (b) VSA. (c) MOL. (d) General description of what metrics mean. Note that frequency bins here are spaced at 10 Hz for brevity, instead of the 2-Hz spacing used elsewhere in this investigation.

The question must be asked: Is it preferable to maintain multichannel presentation at the cost of location-dependent frequency response variations resulting from unoptimized bass? Which is more objectionable and to what degree? To the authors' knowledge, this has not been directly addressed by published research. The question that has been addressed is: Can listeners hear the difference between two-channel and single-channel presentation of two-channel bass material? If it can be shown that listeners cannot hear the difference, the first question becomes moot.

Some investigations seem to indicate that below 80 Hz the difference is not audible [13]–[15]. These and similar studies were somewhat preliminary in nature, and did not always match the assumptions in the current study. Some lacked rigorous statistical analysis. In [16] a more rigorous study was made, which found significant detection rates. The setup used contrived test signals presented in an anechoic chamber, which cannot be assumed to be applicable to a real room with typical source material. A more recent investigation [17], using pink noise in a small listening room, concludes that the audible effects benefiting from channel separation relate to frequencies above about 80 Hz. (In their conclusion the authors cite a “cutoff-frequency boundary between 50 Hz and 63 Hz,” that is, the center frequencies of the octave bands of the noise used as test program material. When the upper frequency limit of each band is taken into account, the numbers change to around 71 and 89 Hz, with an average of 80 Hz.)

A study by one of the authors [18] was based on listening in a real room using several music test signals and one contrived signal. The three music test signals and one contrived signal were chosen to have naturally high decorrelation in the bass region, and nuisance variables were strictly controlled. For music signals below 80 Hz this study found statistically significant detection rates in only one case—the comparison of front center mono bass to two channel bass (subwoofers at  $\pm 90^\circ$ ). So far, *preference* for mono or two-channel playback of bass signals has not really been addressed. It is assumed that the “stereo” bass would be preferred.

In summary, current published research seems to indicate that spatial effects below 80 Hz due to the bass management of two-channel source material using music signals in real rooms are subtle at best, and nonexistent for the bulk of popular music, which employs predominantly mono bass. On the other hand, not using bass management can result in seat-to-seat variations of 40 dB or more at some frequencies or similar variations at one seat from different subwoofers [11]. Therefore we find no justification for the argument that optimization methods that rely on bass management are inherently objectionable. Most investigations so far have assumed that the subwoofers are located at reasonably similar distances from the listener. If a subwoofer is located very near a listener, there may be a moderate localization “pull” toward that subwoofer under certain conditions (such as listening to subwoofers only, distortion products, or port noise from the subwoofer). It should be pointed out that when the seating area is a substantial fraction of the room, this may be an issue regard-

less of how many subwoofer there are and whether they are bass-managed.

#### 4 STANDARDIZED POSITIONAL OPTIMIZATION OF MULTIPLE SUBWOOFERS IN RECTANGULAR ROOMS

Rectangular rooms represent a large proportion of listening spaces. When multiple subwoofers are available for optimization, the possibilities for optimization over a seating area are much improved, since systematic manipulation of modal excitation is possible. One of the earliest examples of multiple-subwoofer optimization for fixed seating in a rectangular room is found in [9]. Since that time many general suggestions and rules of thumb have been discussed, but in general they have not been tested systematically.

One of the authors [19] made an in-depth investigation to determine which configurations were optimal in a rectangular room with the typical seating arrangement shown in Fig. 4. Investigations were based on numerical modeling of the space as well as an actual measurements in the room, which were found to be in reasonable agreement. Instead of using a flat magnitude response target, as generally has been used in the past, metrics based on seat-to-seat variance were used to characterize performance. A number of different room dimensions as well as two different seating configurations were also investigated, again with the same overall results.

By analyzing over 100 000 subwoofer configurations it was shown that for configurations of one to four subwoofers, location at wall midpoints is optimal. Fig. 5 shows some of the configurations tested, starting with one-subwoofer configurations and ending with 18-subwoofer configurations. Four subwoofer at the wall midpoints (configuration 11) was the best practical configuration in terms of MSV. Two subwoofers at opposing wall midpoints (configuration 6) was nearly as good and also offered stronger low-frequency support. Configurations with more than four subwoofers were not found to be advantageous, especially when cost is factored in. These results appear to be generalizable to reasonably dimensioned rectangular spaces [19]. A generalization to nonrectangular rooms or rooms where low-frequency absorption is very unevenly distributed is not possible.

Fig. 6 shows MSV as a function of room length and width, calculated over a 3-m by 3-m grid of 16 seats centered in the room, for six subwoofer configurations. Room dimensions range from 4 to 9 m, and the ceiling height is 2.7 m. Similar results were obtained with 2.4-m and 3.0-m ceilings. It can be seen that the performance of a given subwoofer configuration depends to some degree on the specific room. While optimizing room dimensions without a knowledge of subwoofer or seating area configurations is next to meaningless, choosing a subwoofer configuration and room dimensions for a known seating configuration can be very useful. An interesting observation can be made by looking at the 1:1 room dimension case, namely, a square room. This is seen by looking along an imaginary line from the lower left to the upper right

corners of each plot. It is apparent that square rooms are not necessarily as bad as they have been assumed to be due to overlapping axial modes. In fact, square rooms are preferable for configurations 5 and 6. Fig. 7 shows the perhaps more typical case, where the seating area is between the center and the back of the room. The results are more complex, though configurations 3, 5, and 6 are still better overall.

### 5 OPTIMIZATION OF MULTIPLE SUBWOOFERS USING HIGH-ORDER FILTERS

The optimization of multiple subwoofers for multiple seating locations in real rooms has often been approached by using high-order FIR filters for each subwoofer. The following discussion assumes linearity and time invariance in the properties of the multiple-source multiple-receiver system.

Fig. 8 illustrates such a system in a room. Here  $I$  is the signal input to the system. The loudspeaker-room transfer functions from loudspeakers 1 and 2 to two receiver locations in the room are shown as  $H_{11}$  through  $H_{22}$ , while  $R_1$  and  $R_2$  represent the resulting frequency responses at two receiver locations. Each source has a transmission path to each receiver, resulting in four transfer functions in this example. Assuming the signal sent to each loudspeaker can be electrically modified, we can add  $M_1$  and  $M_2$ , which represent these modifications. Here  $M$  is a complex modifier that may or may not be frequency dependent. Mathematically this can be described in the frequency domain as follows:

$$\begin{aligned} R_1(f) &= IH_{11}(f)M_1(f) + IH_{21}(f)M_2(f) \\ R_2(f) &= IH_{12}(f)M_1(f) + IH_{22}(f)M_2(f) \end{aligned} \tag{7}$$

where all transfer functions and modifiers are understood to be complex. This is recognized as a set of simultaneous linear equations and can be more compactly represented in matrix form,

$$\begin{bmatrix} H_{11} & H_{21} \\ H_{12} & H_{22} \end{bmatrix} \begin{bmatrix} M_1 \\ M_2 \end{bmatrix} = \begin{bmatrix} R_1 \\ R_2 \end{bmatrix} \tag{8}$$

or simply,

$$HM = R \tag{9}$$

A typical goal for optimization is to have  $R$  equal unity. We can then think of  $R$  as a target function. Note that this approach attempts to make the responses at  $R$  consistent and simultaneously to equalize them globally to a target. This could be considered an advantage. On the other hand it might not be an advantage if a more sophisticated global equalization procedure is desired (such as regularization). Eq. (9) can be solved directly for  $M$  by inverting  $R$ , with the inversion calculated for each frequency to be optimized. To get a nearly perfect result in the real world may require long filters with high gains at certain frequencies, or it may require multirate processing (incurring some additional processing load). Windowing of the FIR filters to a modest length may degrade the solution somewhat. Another problem that can arise is that  $H$  may be ill-conditioned such that an inverse is unduly sensitive to noise or implies unrealistically high gains for some loudspeakers at some frequencies [20]. One solution to this would be to simply limit the available gain to any loudspeaker at any particular frequency (as, for example, by regularization [21]). While this would not necessarily give an optimum result, it does have the advantage of reducing the equalization filter length and the resulting latency.

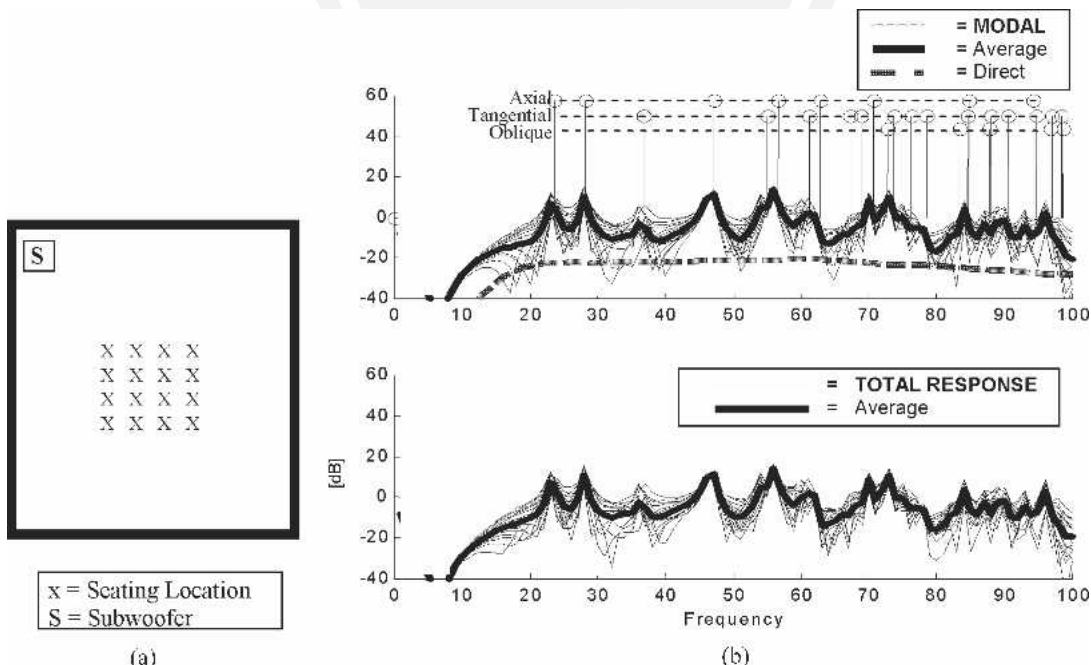

Fig. 4. (a) Room and seating grid (from [19]). (b) Amplitude responses calculated using closed-form solution for rectangular enclosure. Metrics are calculated from total acoustical responses at 16 seats. Axial, tangential, and oblique mode frequencies are also shown. Direct sound plot is for center of seating area.

Other approaches used to deal with ill-conditioned or nonsquare transfer function matrices are often based on singular value decomposition (SVD). Table 1 presents an overview of some commonly used techniques. (See [22] for an excellent overview and also [23]).

Another general approach to the problem is the use of adaptive filters which converge to a solution that minimizes the difference between the measured responses at the receivers and the target responses. The Filtered-x LMS method is a good example [10]. This approach has the

potential to find a slightly better solution than matrix inversion techniques when  $H$  is nonminimum phase. Adaptive solutions have varying degrees of robustness, and may require adjustment of the convergence parameters for best results in different environments.

Using matrix inversion techniques any nonminimum-phase component in the measured room responses  $H$  would result in an acausal equalization filter (or an unstable one in the case of an IIR filter). In the case of an adaptive filter it would not converge to a solution. An

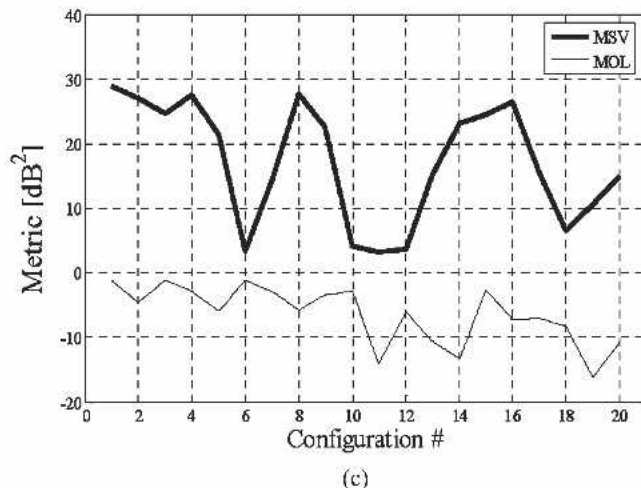
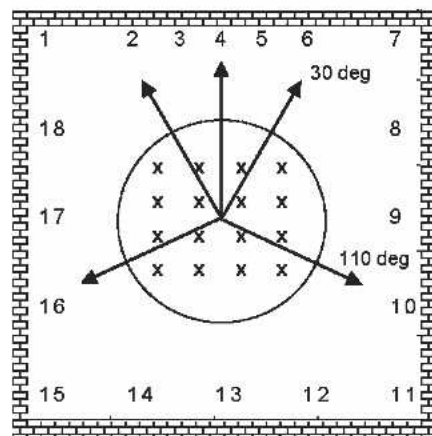
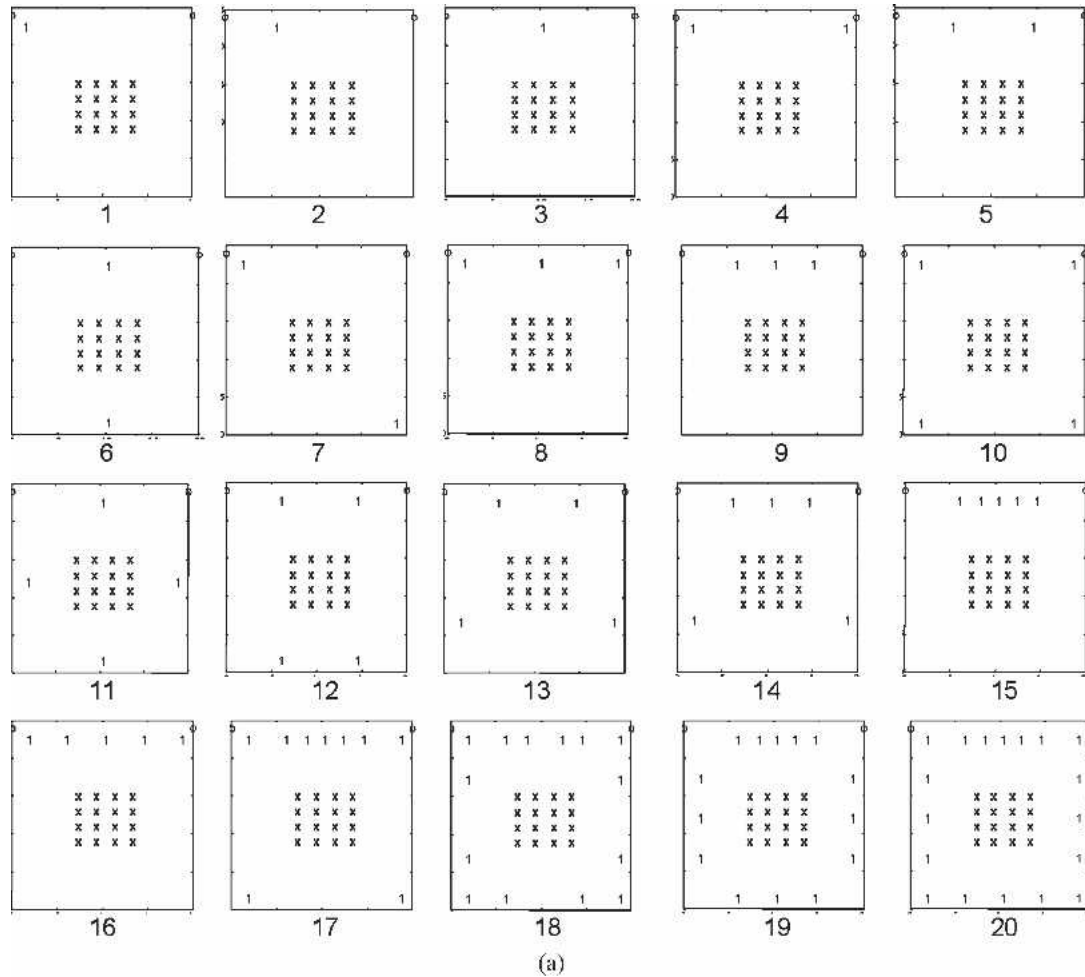

Fig. 5. (a) “Practical” subwoofer configurations in virtual test room (absorption coefficient 0.05). (b) Subwoofer and seat locations. (c) MSV and MOL metrics for all configurations. Note that MOL in (c) is normalized for number of subwoofers used (correction factor  $-20 \log(N)$ ). Correction only to this graph.

appropriate modeling delay must be included in the target function in any of these methods to avoid this problem. High-resolution filters may introduce latency or computational load problems in some situations. One possible disadvantage of this method is that if the derived filters are very high resolution, the improvement at the specified measurement locations may come at the price of increased latency or degraded results at locations between measurement locations.

### 6 OPTIMIZATION OF MULTIPLE SUBWOOFERS USING MINIMAL SIGNAL PROCESSING

The approach discussed in Section 5 assumes the use of arbitrary filters (generally FIR) and fixed subwoofer locations. The current investigation attempts to address the following multiple-subwoofer scenario, which is fairly typical and yet has not been addressed fully by current methods:

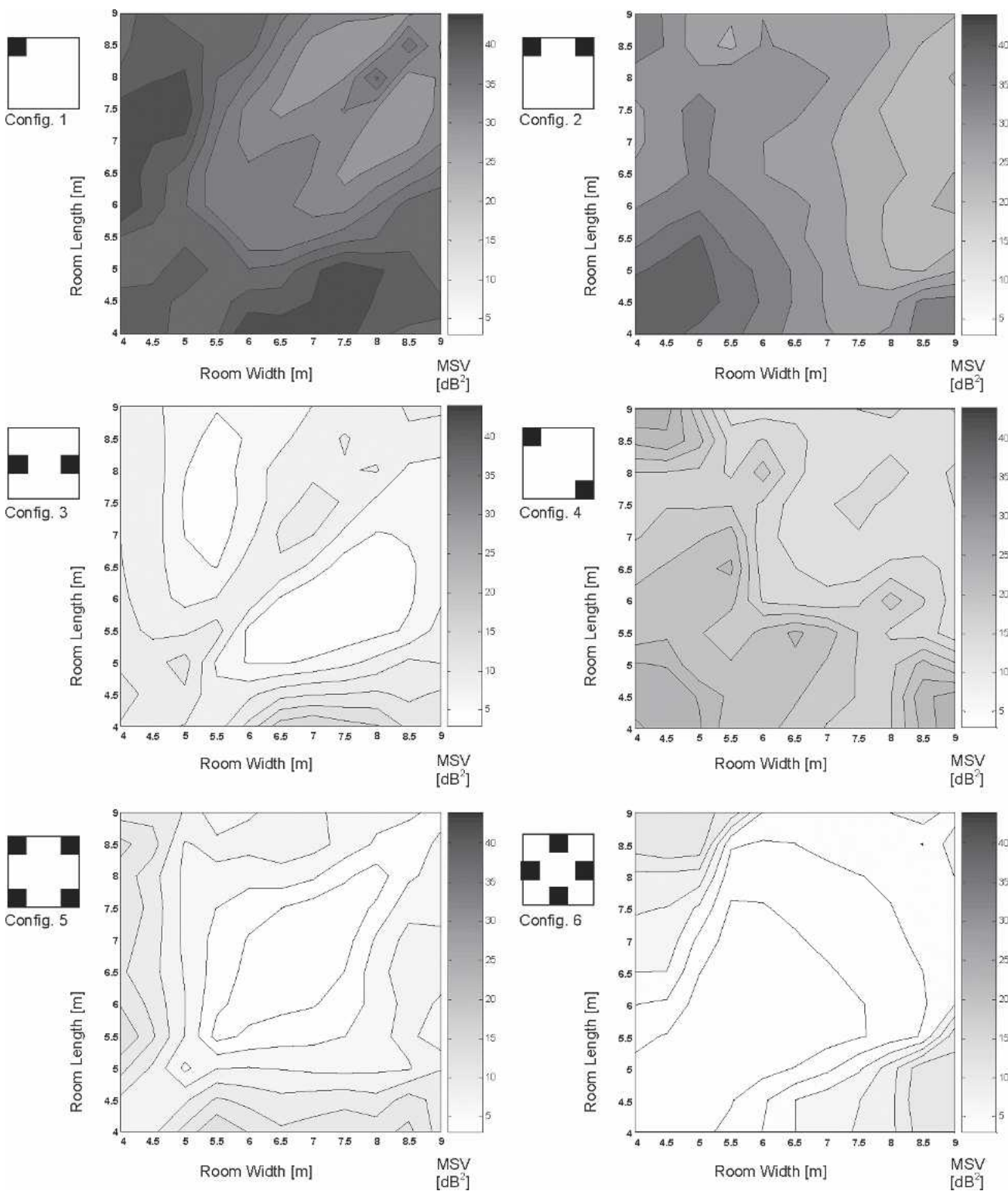

Fig. 6. MSV metric versus room dimensions for six different subwoofer configurations. Seating area is a fixed 2-m by 2-m grid of 16 seats centered in room (absorption coefficient 0.05).



- Simple signal processing is available (some combination of a single biquad filter for each subwoofer, signal delay, and amplitude control). Filters are not arbitrary, but are from a set of simple IIR filters such as might be available on a relatively low-cost commercial DSP box, or incorporated into an active subwoofer.
- Flexible subwoofer locations, that is, there are more potential source locations than actual subwoofers. This is not mandatory but very helpful.

- Arbitrary room shape and construction.
- Arbitrary seating locations.

The approach described here has been developed and tested under the designation sound field management (SFM). SFM emphasizes the use of positional optimization of multiple subwoofers, combined with minimal signal processing. Note that it is possible to calculate optimal FIR filters for each of a number of possible subwoofer

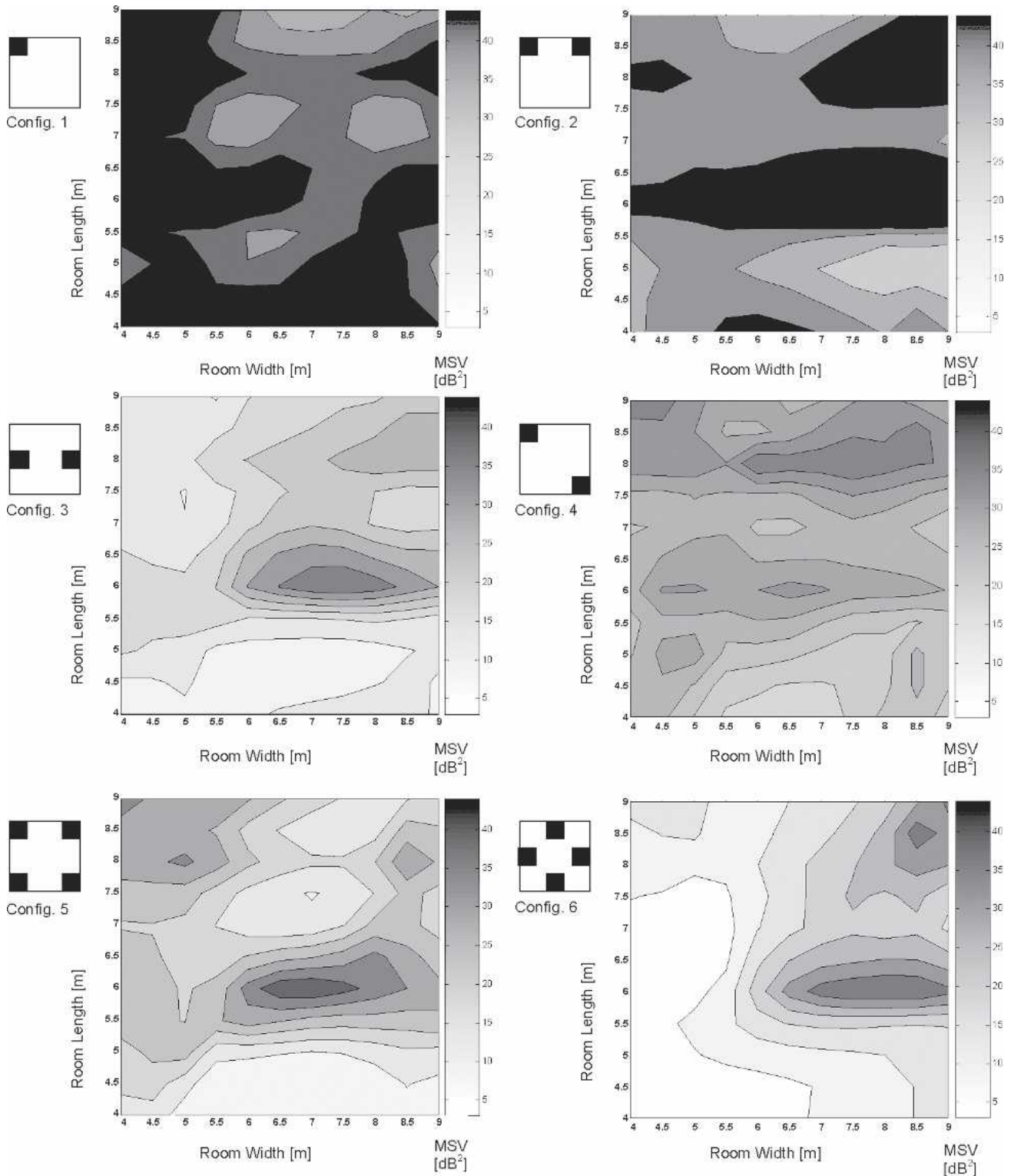

Fig. 7. MSV metric versus room dimensions for six different subwoofer configurations. Seating area is a fixed 2-m by 2-m grid of 16 seats centered approximately one-third room length from rear wall of room (absorption coefficient 0.05).

location combinations using the methods described in Section 5. The best solution might be found and the arbitrarily shaped FIR filters approximated by the closest available IIR filters. However, this approximation would likely not result in the best possible solution.

A fundamental difference between SFM and other approaches is that in SFM there is no target curve. Instead there are several metrics which express various aspects of any given solution. For a particular situation the appropriate metric or weighted combination of metrics can be chosen for optimization. As a consequence of the problem formulation for SFM, the metric to be minimized is not guaranteed to be a simple quadratic function as in the LSE-based methods. Solving this type of problem falls under the category of global optimization procedures (GOPs), which include those based on steepest descent, simulated annealing, genetic algorithms, and others. The optimization method used in this study is based on a grid-search algorithm [24], modified for this particular application. This method has several advantages:

- 1) Is perfectly robust.
- 2) Finds best solution based on available, not arbitrary set of simple filters.
- 3) No algorithmic parameters to adjust (such as convergence rate).
- 4) Is simple to modify. For example, if signal delay is not an option one can simply remove delay from the search grid for an analog-only implementation.
- 5) Real-time DSP requirements are modest. Can be implemented in analog domain.
- 6) Entire solution space is “probed,” giving additional information and allowing multiple best solutions to be further evaluated. For example, the user may decide to trade off a small loss in the MSV metric for a significant gain in the MOL metric.
- 7) Multiple user-defined metrics can be evaluated simultaneously.
- 8) Does not need to be modified for over- or underdetermined matrixes.

The primary disadvantage of this method is its relative inefficiency. However, this has not proved especially onerous given the speed of today’s computers.

### 6.1 Sound Field Management Algorithm

SFM relies on the principle of acoustic superposition to simulate a large number of subwoofer configurations. The first step is to measure the complex transfer functions from each potential subwoofer location to each listening location. Measurements must be complex. The measurements presented in this paper were done using MLSSA [25] with 2-Hz resolution. Room acoustic modeling programs [26]–[28] generally do not provide accurate enough transfer functions for SFM to work. After measurements have been gathered it is possible to calculate the expected response at

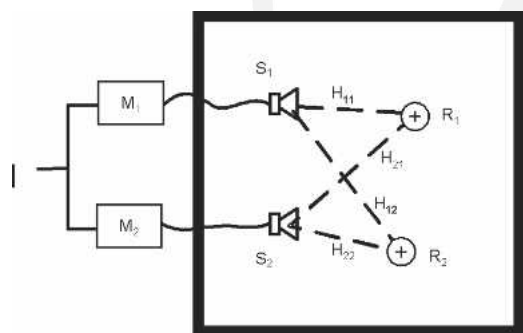

Fig. 8. Example of multiple-subwoofer multiple-receiver system to be optimized.

Table 1. Typical approaches for various multiple-source multiple-receiver matrix inversion conditions.

	Unique Exact Solution	Alternate Solution(s)	Solution Notes
Dimension of $S$ less than dimension of $R$ (overdetermined matrix)	Usually no solution	<ul style="list-style-type: none"> <li>• Minimize error function: <math>\min \ HM - R_d\ ^2</math> where <math>R_d</math> is a target value. Quadratic error function leads to single-error minima. Solution is <math>M = (H^H H)^{-1} H^H P_d</math></li> <li>• Remove excess receiver locations to make square matrix.</li> </ul>	Inversion of $H^H H$ , where $H^H$ is the Hermitian transpose of $H$ , may still be a problem if ill-conditioned, such as if two sources are close together. Use of “effort penalty” weighting in error function guarantees a stable, though not necessarily optimal solution [22]. Effect is similar to smoothing $H$ in the frequency domain.
Dimension of $S$ equals dimension of $R$ (square matrix)	Virtually always	—	—
Dimension of $S$ greater than dimension of $R$ (underdetermined matrix)	Normally an infinite number of solutions	<ul style="list-style-type: none"> <li>• Use singular value decomposition (SVD) to find one exact solution with minimum filter coefficients (minimum two-norm error solution).</li> </ul>	Least likely scenario to be implemented in practical situations.
Ill-conditioned $H$	Usually, but has unrealistic values	<ul style="list-style-type: none"> <li>• Use SVD to calculate matrix inverse, setting small singular values in SVD matrix to 1.</li> <li>• Use smoothing or regularization of <math>H</math> in frequency domain prior to inverting.</li> </ul>	Other approaches exist [20].

any seat for any subwoofer combination simply by adding the individual contributions of each source at each receiver (we assume the system to be linear). In addition the signal to each subwoofer can be modified in a number of ways. A brute-force algorithm searches using a predefined set of allowed modifiers such that all possible combinations of subwoofers and modifiers are calculated and evaluated. The results can then be ranked in terms of MSV, or any other metric, and the best results determined and physically implemented. For maximum efficiency it may be desirable to deviate somewhat from the brute-force method. This is discussed in Section 6.3.

The following modifiers can be optimized using SFM:

- 1) Number and location of subwoofers
- 2) Subwoofer gain
- 3) Subwoofer delay
- 4) Center frequency, attenuation, and  $Q$  of a single bandstop filter per subwoofer.

Because it is impractical to search all possible combinations of these factors, some subset should be chosen. This will determine the resolution of the search grid. A grid that is too coarse is likely to miss the best solutions. Too fine a grid takes too long to search [29, p. 7].

## 6.2 Determination of Search Grid

The first modifier to be considered is subwoofer gain. Intuitively subwoofer-to-subwoofer gain differentials greater than 10 dB would seem wasteful, especially when one considers maximum output level and efficiency at low frequencies. Also a gain-value increment of +6 dB is attractive, since this value could be implemented by doubling the number of subwoofers at a single location. With these factors in mind a range of acceptable gain settings of 0 to -12 dB seems reasonable.

Setting the range for the delay correction factor is far less intuitive. In the end it was decided to limit the amount of delay so as to minimize questions about the time-domain performance of SFM. A cursory examination of [30, figs. 2 and 3] suggests that the relative delay for multiple subwoofers in a typical small room could reach 10 ms or more naturally. This seems like a good initial boundary for the search.

Setting the range for the filter attenuation and  $Q$  parameters is relatively easy. To ensure compatibility with commercial DSP units, the maximum attenuation and  $Q$  values were set to -12 dB and 16, respectively. In order to maxi-

mize the output capability of the system the maximum filter gain is set at 0 dB. Finally limiting the  $Q$  values of the filters to a value greater than 1 seems appropriate, since lower  $Q$  values would simply start to emulate an overall change in the subwoofer gain setting. A filter  $Q$  higher than 16 was not found to be useful (it generally did not result in optimal solutions). Due to the large number of possible filter center frequencies this modifier cannot be optimized using the search grid (see Section 6.3). Filters used in this study are the IIR biquad type, as measured on a dbx DriveRack 260 programmable DSP unit. This yields the nominal search-grid boundaries given in Table 2.

The SFM routine with the nominal search-grid boundaries was tested informally in five rooms and found to be effective. A series of more formal experiments were then run in three rooms to determine the optimal number of levels for each modifier within the search-grid boundaries. From the authors' experience with positional optimization we know that there is little value in using more than four subwoofers. In this investigation the number of subwoofers is limited to this value to investigate the power of the gain, delay, and filter modifiers, and then investigate the effect of subwoofer number and location once the optimum levels for the other modifiers have been determined.

The walls and ceiling of room 1 are constructed from 50-mm by 150-mm wall studs and two layers of 16-mm drywall; carpeting covers a concrete slab floor. As a result this room has significantly less damping than a typical room. The room measures approximately 7.31 by 6.40 by 2.74 m. Room 2 is a dedicated home theater with a dropped ceiling and 50% of the walls covered with 76-mm fiberglass. This room, measuring 6.71 by 5.48 by 2.74 m, has significantly more damping than a typical listening room. Room 3 measures 6.71 by 6.10 by 2.74 m and is typical in terms of construction and furnishing. It also has a large opening into an adjacent room. Fig. 9 shows the configurations of the three rooms.

Table 2. Nominal search-grid boundaries.

Modifier	Range
Gain	0 to -12 dB
Delay	0 to 10 ms
Filter $Q$	1 to 16
Filter attenuation	0 to -12 dB

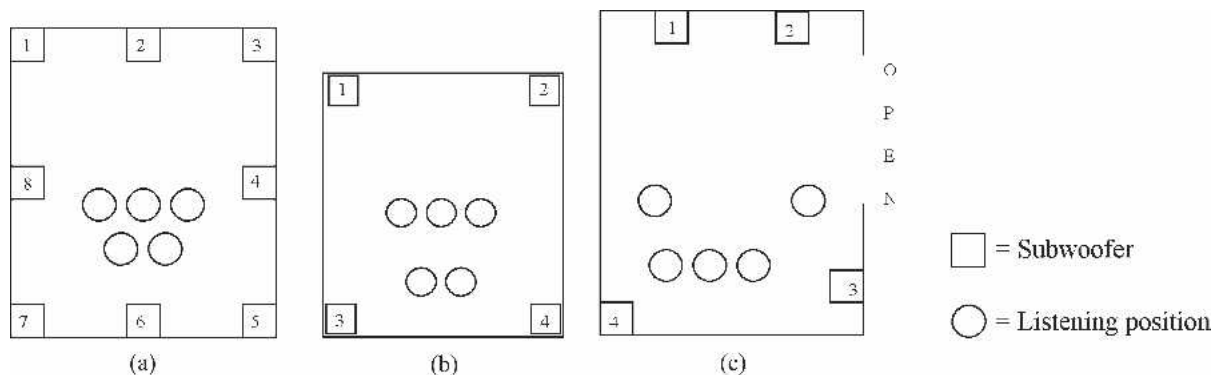

Fig. 9. Subwoofer and seating configurations. (a) Room 1. (b) Room 2. (c) Room 3.

Fig. 10 shows the optimization results for the three rooms with the number of allowed levels for each modifier held constant except for the subwoofer gain. That is, the number of subwoofers is held at four, and the number of levels for the delay and filter modifiers is held at three. The plot shows MSV as a function of computation time on a typical 3-GHz Pentium computer. The markers along each curve represent the number of levels within the search grid. Starting on the left side, the markers represent levels 1 through 6. With three levels the improvement in MSV is dramatic for only a short computation time. After that point the computation time increases rapidly with little improvement in MSV. It is interesting to note that gain was a significantly more powerful modifier in room 3 than in rooms 1 and 2.

Fig. 11 is similar to Fig. 10 except that it shows the results of varying the number of levels for the delay modifier while the number of levels for the other modifiers are held constant. Again, a good compromise between performance and computation time is achieved with three levels. It should be noted that delay is a very effective modifier for room 1.

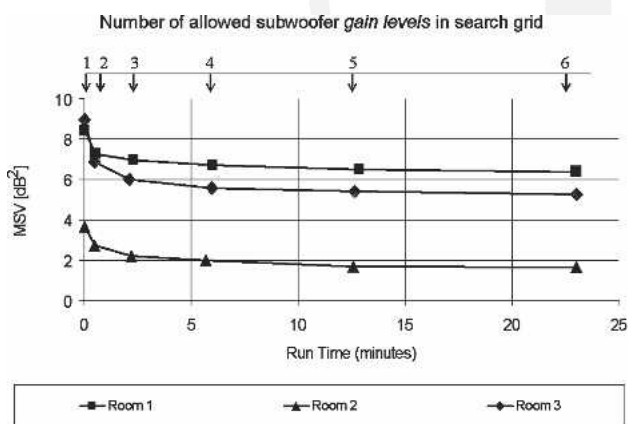

Fig. 10. Plot of MSV versus calculation time when the number of subwoofer amplitudes allowed in search grid is varied while the numbers of allowed subwoofers (4), delay values (3), parametric filter  $Q$  values (3), and parametric filter attenuation levels (3) are held constant.

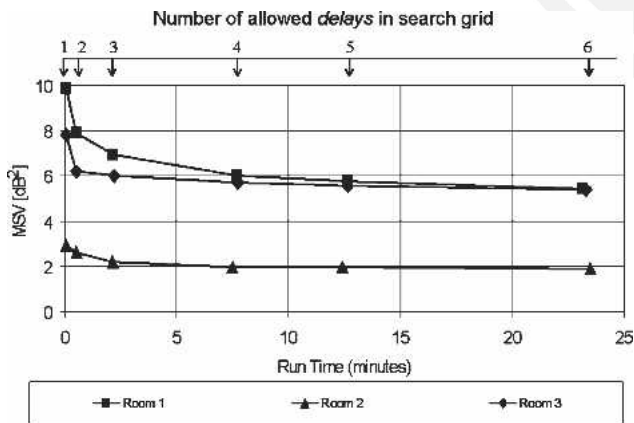

Fig. 11. Plot of MSV versus calculation time when the number of delay levels allowed in the search grid is varied while the numbers of allowed subwoofers (4), drive levels (3), parametric filter  $Q$  values (3), and parametric filter attenuation levels (3) are held constant.

We can scale and combine the data from the three rooms to get a sense of what these modifiers might do in an “average” room. This is plotted in Fig. 12. These data suggest that subwoofer gain and delay are equally powerful modifiers in the general sense. Since holding one modifier at three levels is rather arbitrary it was decided to plot the situation where the number of levels for both subwoofer gain and delay are set to four (while the number of filter correction levels remain at three). The location of this data point on the graph supports the notion that, in a general sense, the amount of computing time correlates with the improvement in MSV, regardless of how the computing time is divided between gain and delay. This seems logical, since the computing time is related directly to the total number of data points in the search grid.

Fig. 13 shows the effect of filter attenuation on MSV. It is very clear from these data that only two values of filter attenuation are required (0 dB and -12 dB). Finally, Fig. 14 shows the effect the number of  $Q$  values can have on MSV. While the number of possible  $Q$  values is not particularly critical, increasing the number of  $Q$  levels does not increase the computation time significantly either. A number of  $Q$  levels of three is adequate.

Now that we have determined the optimum number of levels that can be applied to the modifiers in Eq. (9) we

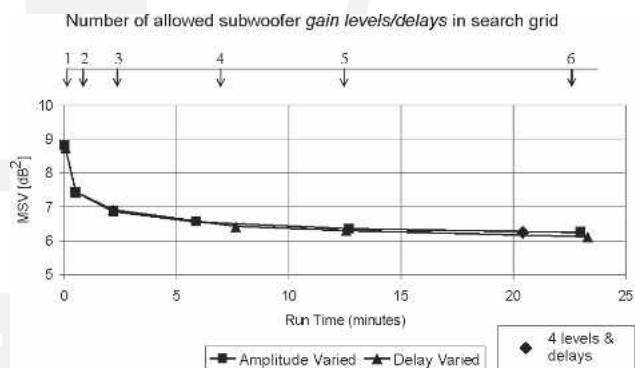

Fig. 12. Plot of MSV versus calculation time for combined rooms when the numbers of drive levels and delay values allowed in search grid are varied while the numbers of allowed subwoofers (4), parametric filter  $Q$  values (3), and parametric filter attenuation levels (3) are held constant.

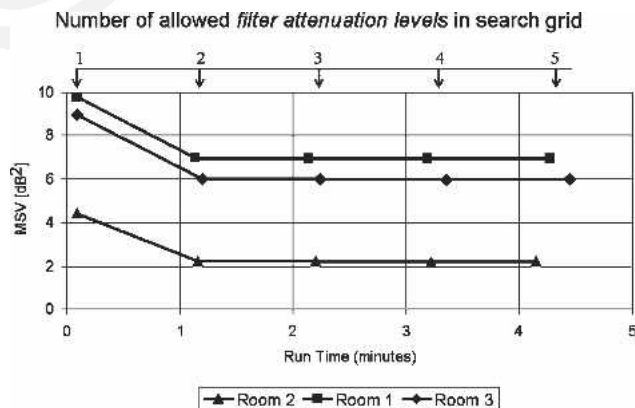

Fig. 13. Plot of MSV versus calculation time when number of parametric filter attenuation levels allowed in search grid is varied while the numbers of allowed subwoofers (4), drive levels (3), and parametric filter  $Q$  values (3) are held constant.

can turn our attention to the number of subwoofers and their locations. Combined, these two factors can greatly affect the computation time, memory requirements, and the resulting MSV. In a listening room there are often several potential subwoofer locations. But which ones are best? For nonrectangular rooms choosing the best single subwoofer location is a laborious task at best. For multiple subwoofers the task becomes nearly impossible. With SFM we simply measure the transfer function of all potential subwoofer locations to each listening location. Then the SFM routine will search through all possible subwoofer combinations to determine the best solution. Fig. 15 shows the effect that limiting the actual number of subwoofers has on room 1. In this example eight potential subwoofer locations were identified. From left to right each square marker represents the number of actual subwoofers allowed. For example, the second square represents the MSV with the best combination of two subwoofers from a potential eight locations. When one notes that the  $x$  axis of this plot (the calculation time) is logarithmic it should be clear that four subwoofers represents a good compromise. Table 3 shows the default search grid.

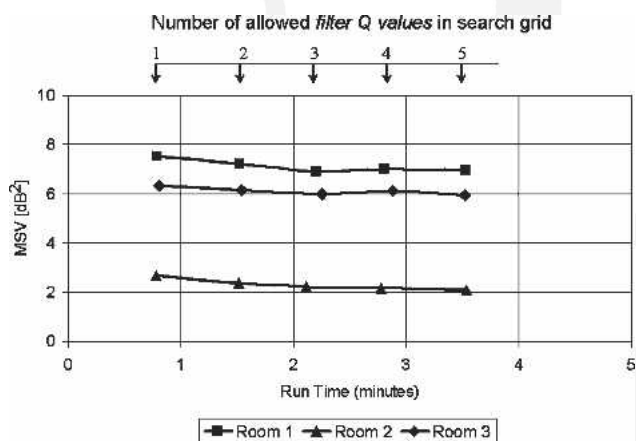

Fig. 14. Plot of MSV versus calculation time when the number of parametric filter  $Q$  values allowed in the search grid is varied while the numbers of allowed subwoofers (4), drive levels (3), and parametric filter cut levels (3) are held constant.

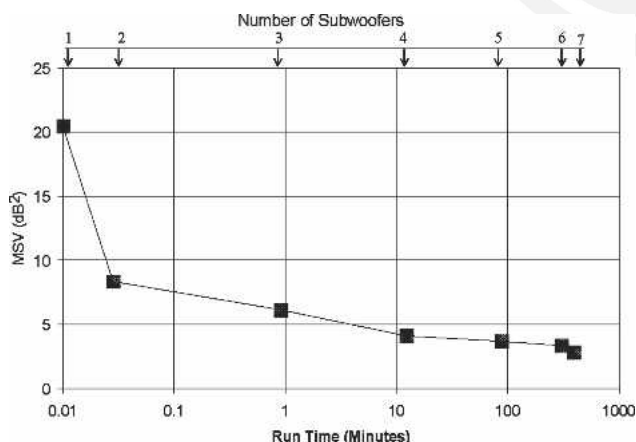

Fig. 15. Plot of MSV versus calculation time when all search parameters are held constant except number of subwoofers allowed (total number of subwoofer positions in room is eight).

The result of this experimentation led to the “default” search grid for the SFM optimization process. However, the search grid may be modified for specific applications. For example, if no delays are available, the number of allowed gains, filter  $Q$ s, and filter attenuation levels in the search grid can be increased. This can compensate for the lack of delays, but only to a certain extent.

### 6.3 Modifications to Brute-Force Approach

The practical implementation of the SFM technique may benefit from some modifications to the pure brute-force approach:

1) *Filter Center Frequency.* Due to the high frequency resolution of the simulations (2 Hz), to include all possible filter center frequencies in the search grid would increase the calculation time enormously. One solution is to put filters only where they are needed. Looking at Fig. 4 we see that the seat-to-seat variance can be quite large at certain frequencies, and almost zero at others. Intuitively the application of a filter at frequencies where the MSV is high is more likely to result in an improvement. Conversely, putting filters where the MSV is already low is unlikely to result in an improvement. After each subwoofer has had a filter applied and optimized, the MSV can be recalculated to see at what frequency the filter for the next subwoofer should be applied. This process can be repeated for each possible ordering of filter applications to individual subwoofers, and the best solution retained. In the current implementation each subwoofer may have only one filter applied to it, though some subwoofer may have no filter at all (if no filter could be found for that subwoofer that would improve the overall spatial variance).

2) *Redundant Combinations of Gain and Delay.* Redundant combinations of subwoofer gain and delay are those that do not vary relative to each other, and thus represent only an overall change in gain and delay for the entire system. As an example, given a two-subwoofer system with gains of 0 and  $-6$  dB, there is no need to calculate the case of  $-6$ - and  $-12$ -dB levels (even though that is within the nominal search grid). The relative difference between the subwoofers is the same. In this case we would chose the 0- and  $-6$ -dB case as having the highest overall output. Thus we can prune many redundant gain–delay combinations out of the search grid.

### 6.4 Output of SFM Search

The output of the SFM search routine is a database of one or more metrics calculated for each grid point searched. These can be sorted as shown in Fig. 16, which presents the top five solutions out of several million searched, for an example calculation where four subwoofer locations out of a possible eight locations are cho-

Table 3. Nominal search-grid steps.

Modifier	Steps
Gain	0, $-6$ , $-12$ dB
Delay	0, 5, 10 ms
Filter $Q$	1, 4, 16
Filter attenuation	0, $-12$ dB

sen in room 1. The solutions are ranked according to the lowest MSV. Two other metrics, VSA and MOL, are also shown as well as the selected subwoofers and modifiers for each solution. This illustrates an important advantage of this grid-search method—it gives more information than just the best single solution for a given metric. It allows alternative solutions to be considered for specific situations. For example, solution 2 performs very nearly as well as solution 1 in terms of MSV, but gives more bass output (MOL) and a slightly flatter response on average (VSA). It is also possible to allow the user to weight the priority of the metrics in any desired way and report the results. An example would be that the user does not want to have one particular subwoofer (unavoidably located near the listener) driven at a high level. The top solutions can be searched to find one where that subwoofer is attenuated or delayed relative to the others. This is easily accomplished once the search algorithm is finished and the results are cataloged.

### 6.5 Results of Sound Field Management for Rooms 1, 2, and 3

Once a prospective solution is chosen, it can be plotted. The measured response should be very close to the predicted response, assuming the system is linear and there is minimal measurement error. Fig. 17 shows an example for room 2. Figs. 18–26 show overall results of SFM for room 1. A total of eight subwoofer positions and five listening locations were measured to yield 40 transfer functions. Several scenarios were then evaluated. All of the results in this section are generated using real measured data. Fig. 18 shows the performance for the common scenario of a single subwoofer in a front corner. This is compared in Fig. 19 to the single best subwoofer found by SFM. Fig. 20 shows the performance for the common front left and front right configurations [Fig. 9(a), subwoofers 1 and 3], whereas Fig. 21 shows the performance of the best subwoofer pair with no optimization. Fig. 22 shows the best

two-subwoofer configuration after SFM was applied. Fig. 23 shows the performance for a four-wall–midpoint configuration similar to the one described in [19]. Fig. 24 shows the performance of the same four subwoofers once SFM has been applied. Fig. 25 shows the performance of the four corner subwoofers optimized. Fig. 26 shows the performance of the best four-subwoofer optimized configuration. Table 4 tabulates the results for rooms 1–3.

From Table 4 we see that using the wall midpoints in room 1 (as per [19]) improved MSV significantly. The increase in MOL is a bit less than would be expected if the

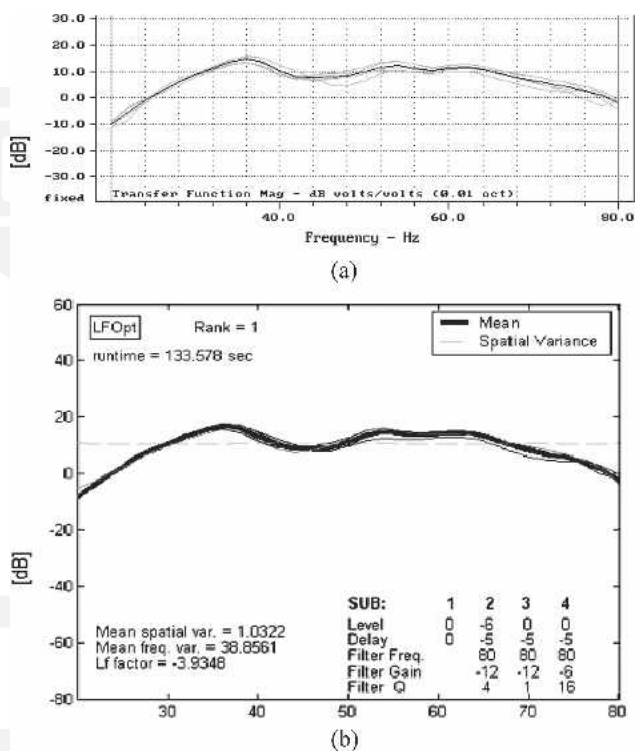
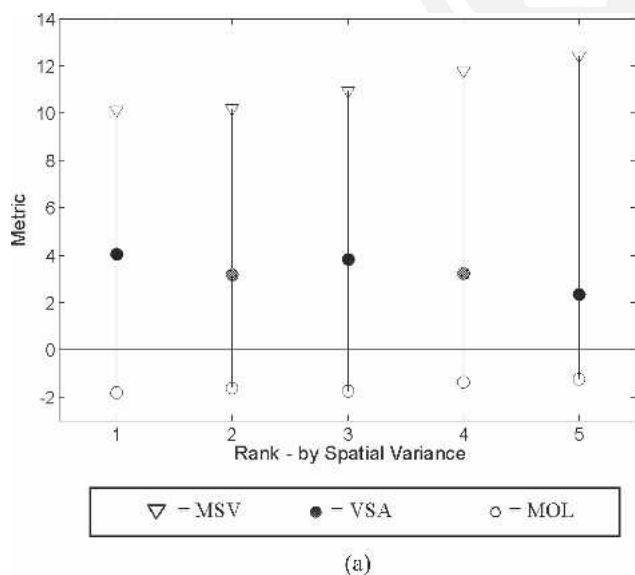

Fig. 17. Comparison of responses in room 2. (a) Measured. (b) Predicted. Results are in good agreement.



Rank	Subs used	Gain	Delay	Filter Freq.	Filter Level	Filter Q
1	2	0	0	--	0	--
	5	0	5	24	-12	4
	6	0	0	56	-12	8
	7	0	0	--	0	--
2	2	0	0	54	-12	16
	5	-6	5	22	-12	4
	6	-12	10	78	-12	4
	7	-6	5	--	0	--
3	2	0	0	--	0	--
	4	-6	5	46	-12	16
	6	0	0	42	-12	16
	9	0	5	42	-12	4
4	2	0	0	80	-12	4
	5	0	0	58	-12	4
	6	-12	0	--	0	--
	8	0	0	44	-12	8
5	2	0	0	--	0	--
	5	-6	10	24	-12	4
	6	-6	10	52	-12	16
	4	-6	10	50	-12	8

(b)

Fig. 16. (a) Example of output from SFM program, showing top-ranked solutions out of many thousands analyzed (ranked by MSV). (b) Subwoofers used, drive levels, delays, and resulting metrics for each solution.

second subwoofer were located directly adjacent to the first one, that is, 6 dB. Picking the best two subwoofer locations improved MSV even more (by an average of 7.1 dB<sup>2</sup> for all rooms). Interestingly, in room 1 the best two subwoofers were not located at wall midpoints. This was likely due to the fact that the room has different and non-real acoustical impedances in the front and back walls. This has the effect of shifting modal peaks and nulls spatially in this direction. Since this is a not uncommon occurrence in real rooms, it highlights the fact that the wall

midpoint configuration recommended in [19] is only preferable in a general sense. It is always better to measure a real room and select the best subwoofer locations if possible. MOL improved by an average of 6.7 dB compared to the reference single subwoofer when choosing the best two subwoofers, about the same as would be expected by putting the second subwoofer directly adjacent to the reference subwoofer.

Adding gain–delay–filter optimization lowered the MSV by an average of 13.9 dB<sup>2</sup> when two subwoofers

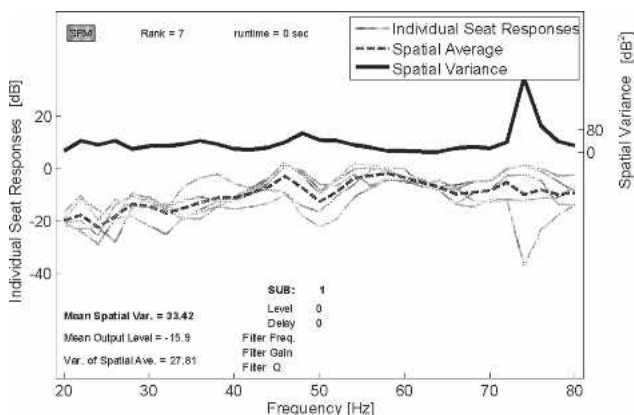

Fig. 18. Reference configuration in room 1; one subwoofer in front left corner.

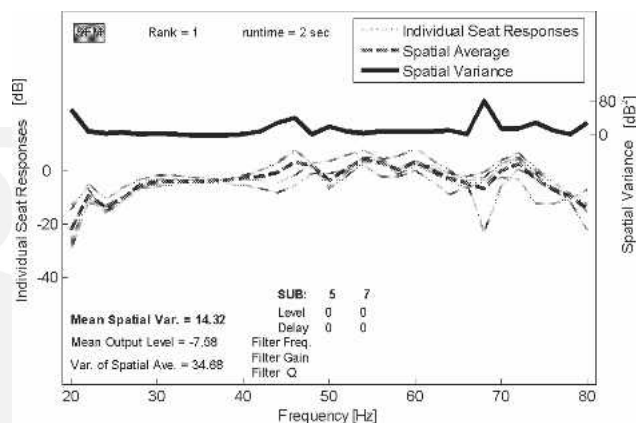

Fig. 21. Best two-subwoofer configuration, room 1. No optimization.

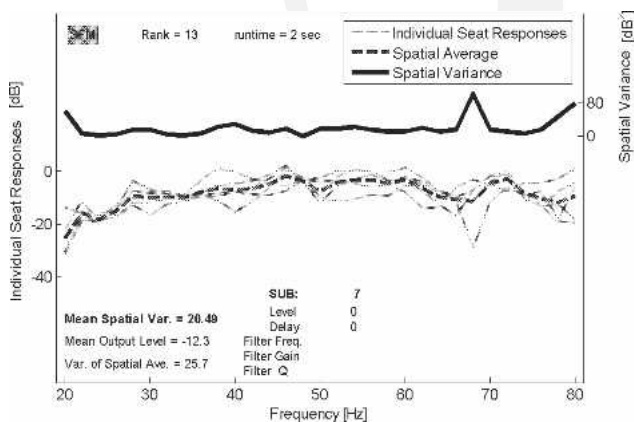

Fig. 19. Best single subwoofer, room 1. No optimization.

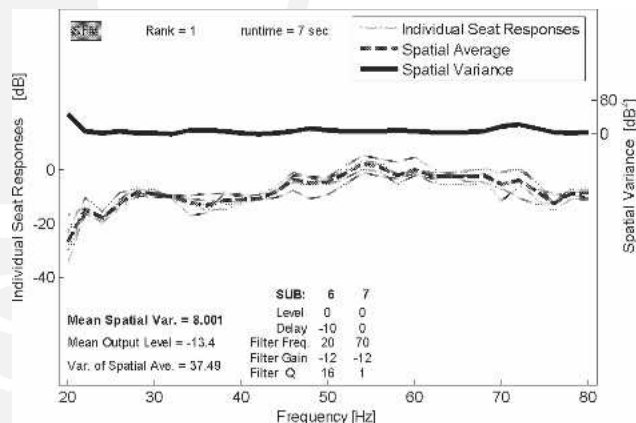

Fig. 22. Best two-subwoofer configuration, room 1. Optimized using SFM.

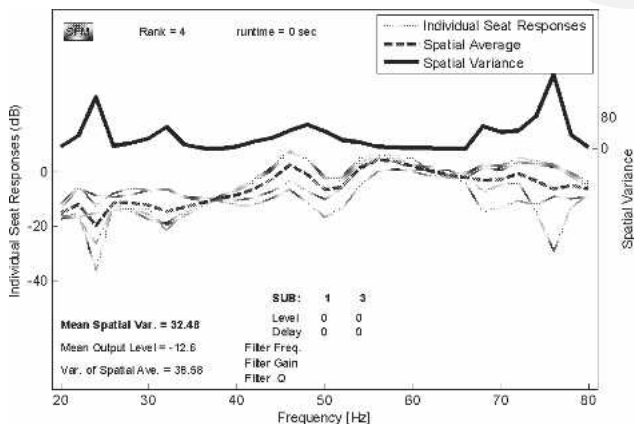

Fig. 20. Typical subwoofer configuration, subwoofers 1 and 3 [Fig. 8(a)]. No optimization.

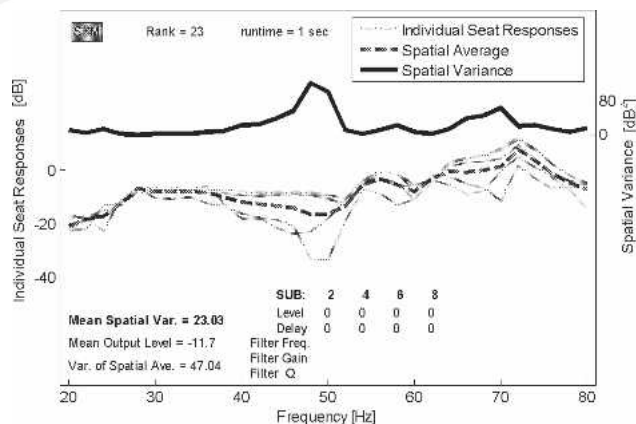

Fig. 23. Wall midpoint configuration (subwoofers 2, 4, 6, 8, from [19]), room 1. No optimization.

were used, while allowing four subwoofers to be used resulted in a 16.6-dB<sup>2</sup> reduction in average MSV, compared to the reference of one subwoofer. MOL was increased by 3.2 and 6.4 dB, respectively, as compared to an expected increase of 6 and 12 dB if the additional subwoofers were placed next to the reference subwoofer. This shows that there is some relative loss when multiple subwoofers are spread throughout the room because of mode cancellations. Due to the sheer number of subwoofers used, bass output is likely to be sufficient anyway.

### 6.6 Comparison of Matrix Inversion and Sound Field Management for Room 1

Using an implementation of a modified matrix inversion technique, a comparison was made to SFM in room 1. The matrix inversion algorithm uses complex smoothing to limit the FIR filter length to 4096 taps and to limit the maximum gain of the filter. Eight subwoofers located around the room periphery and four seats representing an enclosed seating area were measured, and the data were input to both the SFM and the matrix inversion algorithms. All possible groups of four out of eight subwoofers were analyzed, and the resulting MSVs were tabulated. Results presented in Fig. 27 show that in this case SFM generated significantly lower MSV metrics. It should be noted that the matrix inversion algorithm tested also performs global equalization, whereas the SFM requires additional equalization to flatten the response. Further investigations in additional rooms and for different seating configurations are currently under way.

### 7 CONCLUSION

The various investigations described in this paper suggest the following approaches for different situations:

- 1) Rectangular room, dimensions unknown, or no measurements available, seating area in center of room or between

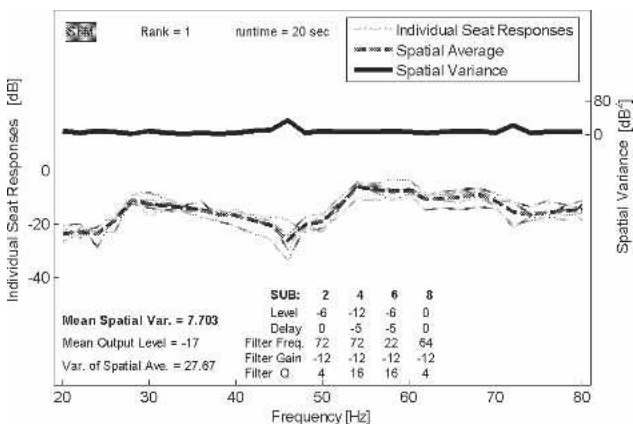

Fig. 24. Wall midpoint configuration (subwoofers 2, 4, 6, 8, from [19]), room 1. Optimized using SFM.

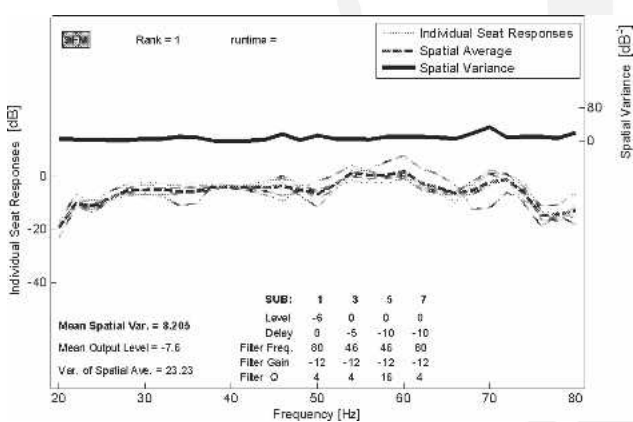

Fig. 25. Corner-subwoofer configuration (subwoofers 1, 3, 5, 7), room 1. Optimized using SFM.

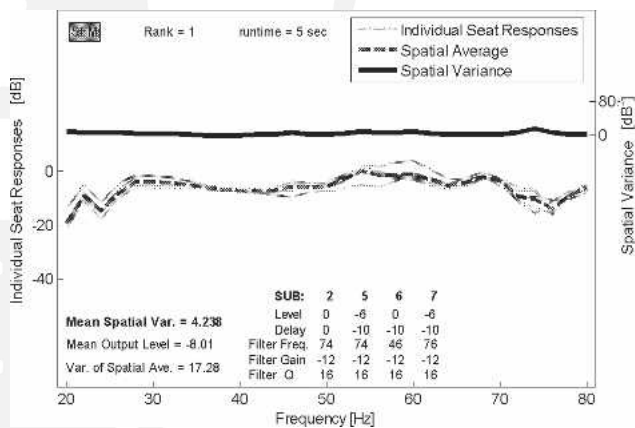

Fig. 26. Best optimized four-subwoofer solution, room 1. Using SFM.

Table 4. Summary of results for rooms 1–3.\*

	Reference			Positional Optimization 1			Positional Optimization 2			SFM			SFM		
	Subs Used	MSV	MOL	Subs Used	MSV	MOL	Subs Used	MSV	MOL	Subs Used	MSV	MOL	Subs Used	MSV	MOL
Room 1	1	33.4	0	4, 8	23.7	3.7	5, 7	14.3	13.7	6, 7	8.0	7.9	2, 5, 6, 7	4.2	13.3
Room 2	1	16.6	0	Not measured			1, 4	7.2	7.0	1, 4	4.7	4.4	1, 2, 3, 4	3.2	4.8
Room 3	4	14.4	0	Not applicable; room not rectangular			1, 4	21.5	-0.5	3, 4	10.1	-2.6	1, 2, 3, 4	7.3	1.2

\* Note that MOLs in table are not corrected for number of active subwoofers as in Fig. 5, to give a better idea of actual expected bass output. Refer to Fig. 9 for subwoofers used. MOLs are normalized to reference case.



center and rear: use standardized positional optimization.

2) Rectangular room, dimensions known, no measurements available, seating area in center of room or between center and rear: use Figs. 6 or 7 to select either the best subwoofer configuration or the best combination of subwoofer configuration and room dimensions (better).

3) Subwoofer-to-seat measurements and DSP hardware with high-order filters available: use filters based on matrix inversion or adaptive techniques, or use SFM solutions.

4) Subwoofer-to-seat measurements available and DSP hardware limited or unavailable: use SFM solutions.

SFM has been shown to have several advantages over other methods. It performs better than using standardized locations only (such as wall midpoints). It may be simpler to implement than complex FIR filter-based techniques. The performance of SFM compared to FIR filtering is the subject of continued investigation, though preliminary indications are that they perform similarly on average. The use of SFM allows the user to look at a number of the best solutions and pick the one most suited to a specific need, rather than simply calculating one and only one solution. Since it is based on a grid-search algorithm, SFM could be implemented simply as a series of nested loops. Adding a bit of intelligence, for example, eliminating redundant level and delay combinations, improves performance considerably.

## 8 ACKNOWLEDGMENT

This work was funded by Harman International Industries. The authors would like to thank Sean Olive, Richard Small, Pedro Manrique, and Kevin Voecks for their support and comments. They would like to extend a special thank you to Monica Reiss for help with the programming and to Floyd Toole for the inspiration, guidance, and support he supplies so freely.

## 9 REFERENCES

- [1] P. M. Morse, *Vibration and Sound* (McGraw-Hill, New York, 1948), pp. 313, 418.
- [2] P. M. Morse and K. U. Ingard, *Theoretical Acoustics* (McGraw-Hill, New York, 1968), pp. 576–598.
- [3] J. Borwick, Ed., *Loudspeaker and Headphone Handbook* (McGraw-Hill, New York, 1968), ch. 7.

- [4] *Matlab*, The Mathworks, Natick, MA 01760-2098.
- [5] R. V. Waterhouse, "Output of a Sound Source in a Reverberation Chamber and Other Reflecting Environments," *J. Acoust. Soc. Am.*, vol. 30, pp. 4–13 (1958 Jan.).
- [6] R. F. Allison, "The Influence of Room Boundaries on Loudspeaker Power Output," *J. Audio Eng. Soc.*, vol. 22, pp. 314–320 (1974 June).
- [7] O. Jacobsen, "Some Aspects of the Self and Mutual Radiation Impedance Concepts with Respect to Loudspeakers," *J. Audio Eng. Soc.*, vol. 24, pp. 82–92 (1976 Mar.).
- [8] K. O. Ballagh, "Optimum Loudspeaker Placement Near Reflective Planes," *J. Audio Eng. Soc.*, vol. 31, pp. 931–935 (1983 Dec.).
- [9] A. R. Groh, "High-Fidelity Sound System Equalization by Analysis of Standing Waves," *J. Audio Eng. Soc.*, vol. 22, pp. 795–799 (1974 Dec.).
- [10] S. J. Elliott and P. A. Nelson, "Multiple-Point Equalization in a Room Using Adaptive Digital Filters," *J. Audio Eng. Soc.*, vol. 37, pp. 899–907 (1989 Nov.).
- [11] F. Asano and D. C. Swanson, "Sound Equalization in Enclosures Using Modal Reconstruction," *J. Acoust. Soc. Am.*, vol. 98, pp. 795–799 (1995 Oct.).
- [12] F. Toole, "Loudspeakers and Rooms for Stereophonic Sound Reproduction," in *Proc. AES 8th Int. Conf. on the Sound of Audio* (1990 Apr.), paper 8–011.
- [13] J. Borenus, "Perceptibility of Direction and Time-Delay Errors in Subwoofer Reproduction," presented at the 79th Convention of the Audio Engineering Society, *J. Audio Eng. Soc. (Abstracts)*, vol. 33, p. 1008 (1985 Dec.), preprint 2290.
- [14] G. Thiele and C. Kügler, "Loudspeaker Reproduction: Study on the Subwoofer Concept," presented at the 92nd Convention of the Audio Engineering Society, *J. Audio Eng. Soc. (Abstracts)*, vol. 40, p. 437 (1992 May), preprint 3335.
- [15] N. Zacharov, S. Bech, and D. Meares, "The Use of Subwoofers in the Context of Surround Sound Programme Reproduction," presented at the 102nd Convention of the Audio Engineering Society, *J. Audio Eng. Soc. (Abstracts)*, vol. 45, p. 403 (1997 May), preprint 4411.
- [16] W. L. Martens, "Subjective Evaluation of Auditory Spatial Imagery Associated with Decorrelated Subwoofer Signals," in *Proc. 2002 Conf. on Auditory Display* (Kyoto, Japan, 2002 July).

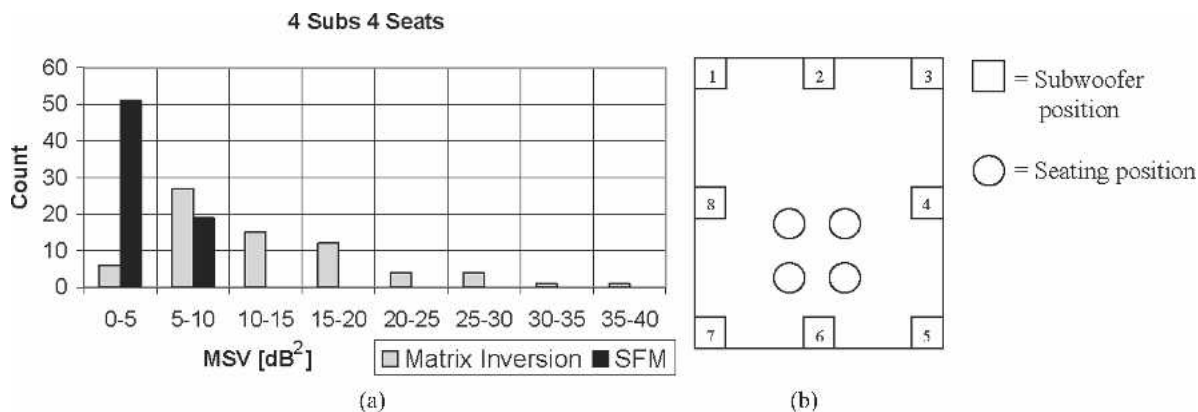

Fig. 27. (a) Histogram of solutions found using an algorithm based on matrix inversion and SFM. All possible groups of four subwoofers out of the eight locations measured were analyzed. (b) Subwoofer and seating layout in room 1.

[17] W. L. Martens, J. Braasch, and W. Woszczyk, "Identification and Discrimination of Listener Envelopment Percepts Associated with Multiple Low-Frequency Signals in Multichannel Sound Reproduction," presented at the 117th Convention of the Audio Engineering Society, *J. Audio Eng. Soc. (Abstracts)*, vol. 53, pp. 98, 99 (2005 Jan./Feb.), convention paper 6229.

[18] T. Welti, "Subjective Comparison of Single Channel versus Two Channel Subwoofer Reproduction," presented at the 117th Convention of the Audio Engineering Society (San Francisco, CA, 2004 October 31), convention paper 6322.

[19] T. Welti, "How Many Subwoofers Are Enough?," presented at the 112th Convention of the Audio Engineering Society, *J. Audio Eng. Soc. (Abstracts)*, vol. 50, p. 523 (2002 June), convention paper 5602.

[20] B. Korst-Fagundes, "Acoustical Equalization at Multiple Listening Positions," UMI Dissertation Services, pp. 34–35 (1999).

[21] O. Kirkeby and P. A. Nelson, "Digital Filter Design for Inversion Problems in Sound Reproduction," *J. Audio Eng. Soc.*, vol. 47, pp. 583–595 (1999 July/Aug.).

[22] J. C. Sarris, N. J. Stefanakis, and G. E. Cambourakis, "Signal Processing Techniques for Robust Multichannel Sound Equalization," presented at the 116th Convention of the Audio Engineering Society, *J. Audio*

*Eng. Soc. (Abstracts)*, vol. 52, p. 805 (2004 July/Aug.), convention paper 6087.

[23] M. Miyoshi and Y. Kaneda, "Inverse Filtering of Room Acoustics," *IEEE Trans. Acoust., Speech, Signal Process.*, vol. 36 (1988 Feb.).

[24] P. M. Pardalos and M. G. C. Resende, Eds., *Handbook of Applied Optimization* (Oxford University Press, Oxford, UK, 2002).

[25] MLSSA Measurement System, DRA Laboratories, Sarasota, FL, USA.

[26] CARA (Computer Aided Room Acoustics), ELAC Technische Software GmbH, Kiel, Germany.

[27] EASE (Enhanced Acoustic Simulator for Engineers), ADA Acoustic Design Ahnert, Berlin, Germany.

[28] Room Optimizer, RPG Diffuser Systems, Inc., Upper Marlboro, MD, USA.

[29] T. Welti and A. Devantier, "In-Room Low-Frequency Optimization," presented at the 115th Convention of the Audio Engineering Society, *J. Audio Eng. Soc. (Abstracts)*, vol. 51, p. 1244 (2003 Dec.), convention paper 5942.

[30] A. Devantier, "Characterizing the Amplitude Response of Loudspeaker Systems," presented at the 113th Convention of the Audio Engineering Society, *J. Audio Eng. Soc. (Abstracts)*, vol. 50, p. 954 (2002 Nov.), convention paper 5638.

## THE AUTHORS



T. S. Welti

Todd S. Welti was born in 1962 in Los Alamos, NM. He received a B.S. degree in electrical engineering from Cogswell College North, Everett, WA, in 1989, and in 2000 he received an International Masters in Acoustics degree from Aalborg University, Aalborg Denmark.

He spent nine years as an acoustical consultant with Michael R. Yantis Assoc., designing and commissioning sound-reinforcement systems from office-masking systems to performance halls to multipurpose arenas. He was also involved in room acoustics design for many lecture rooms, concert halls, and other critical spaces. Currently he is with Harman International in Northridge, CA, where he is involved in research in subwoofer/room optimization, auralization technology, and system equalization techniques, with emphasis on the underlying psychoacoustic principles. He has taught Cedia classes on test and measurement techniques and room acoustics. He is also a Cedia Subject Matter Expert in acoustics, and is a member of the Cedia Designer Level II Certification Committee.



A. Devantier

Mr. Welti is a member of the Audio Engineering Society and the Acoustical Society of America.



Allan Devantier was born on June 6, 1964 in Newmarket, Ontario, Canada. He received a bachelor's degree in electrical engineering technology with honors in 1987 from Ryerson Polytechnical University in Toronto, Canada.

He has been the manager of Objective Evaluation for Harman International since 2002 July. Prior to that he spent four years as the chief engineer for Infinity Systems and three years as the director of Loudspeaker Systems Engineering for JBL Consumer, both divisions of Harman International. He is the inventor of Infinity's Room Adaptive Bass Optimization System and is the coinventor of the Ceramic Metal Matrix Diaphragm cone material and the Sound Field Management system. Prior to joining Harman International he worked as a loudspeaker systems engineer for Plateau Camber and Belbois Ltee., both located in Montreal, Quebec, Canada. He is keenly interested in improving the correlation between objective and subjective loudspeaker performance.

Mr. Devantier is married and has three children.